

Clock Measurements Using the BI220 Time Interval Analyzer/Counter and Stable32

W.J. Riley
Hamilton Technical Services
Beaufort SC 29907 USA

• Introduction

This paper describes methods for making clock frequency and phase measurements using a Brilliant Instruments Model BI220 Time Interval Analyzer (TIA)/Counter [1] along with the Stable32 stability analysis software package [2]. The BI220 (shown in Figure 1) is a board that plugs into a PCI slot in a PC. It has four inputs for the A and B channel signals, a reference signal and an arming signal. The BI220 has 8 ps single-shot time interval resolution, 12 digits per second frequency resolution, and operates from DC to 2.5 GHz (400 MHz direct without prescaler). It can be used as either a single channel frequency counter or a two channel time interval counter or time tagger.



Figure 1. Photograph of BI220 TIA/Counter Board

These tests are conducted with BI220 S/N 700 with FPGA revision 161 and version 2.0.6 of the BI220 BiVirt software.

• Measurement Methods

The following measurement methods are utilized:

1. Direct frequency measurement using the BI220 as a high-resolution counter.
2. Heterodyne frequency measurements using a mixer and offset local oscillator to enhance the BI220 resolution.
3. 1 pps time interval measurements using a pair of dividers to produce 1 pps reference and measurement signals and measuring their time difference with the BI220.
4. A dual mixer time difference (DMTD) clock measurement system utilizing the BI220 as its time interval counter.
5. A DMTD clock measurement system utilizing the BI220 as a two-channel time tagger.

• Reference and Test Sources

The reference source for these measurements is an Efratom LPRO-101 rubidium oscillator and an associated distribution amplifier which is manually calibrated using a Trimble Thunderbolt GPS disciplined oscillator. The test source is a Milliren Technologies MTI 574-0126A 10 MHz OCVCXO set for a frequency offset of about +32 Hz for the frequency counter, heterodyne and 1 pps time interval measurements, and near zero-beat for the DMTD measurements.

- **BI220 Setup**

The BI220 has several setup options that must be entered into their corresponding dialog box screens to configure the instrument for the desired measurement. These screens are shown in Figures 2-4 for setup as a frequency counter. In all cases discussed, an external 10 MHz reference is used without external arming, and the reference input impedance is set to 50 Ω . The A channel input is used for direct frequency measurements, and in that case is also set to 50 Ω with zero threshold voltage and a nominal +7 dBm drive level. The A channel input is also used for heterodyne frequency measurements, with high (1 M Ω) input impedance and a +2.5 volt offset voltage setting appropriate for the mixer/low pass filter and beat note amplifier. The A and B inputs are used for time interval and time tagging measurements, and those are set for high (1 M Ω) input impedance with +2.5 volt offset for 5 volt logic signals.

The BI220 instrument options are set for an external 10 MHz reference with 50 Ω input impedance and a nominal drive level of +7 dBm as shown in Figure 2.

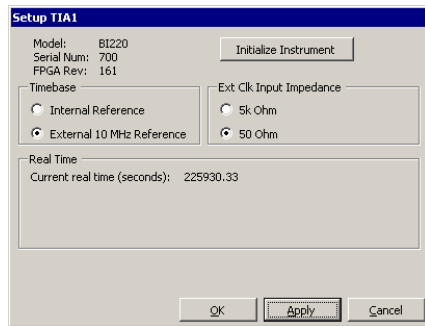
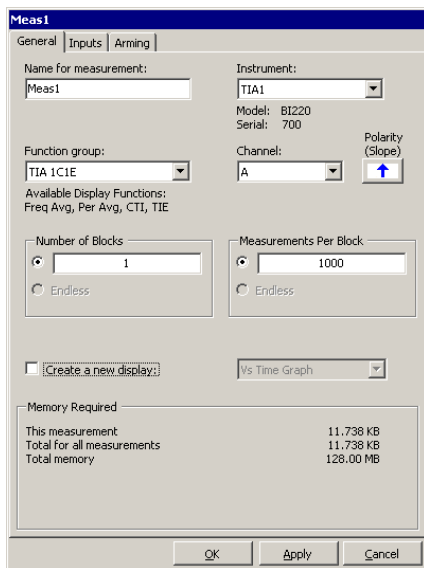
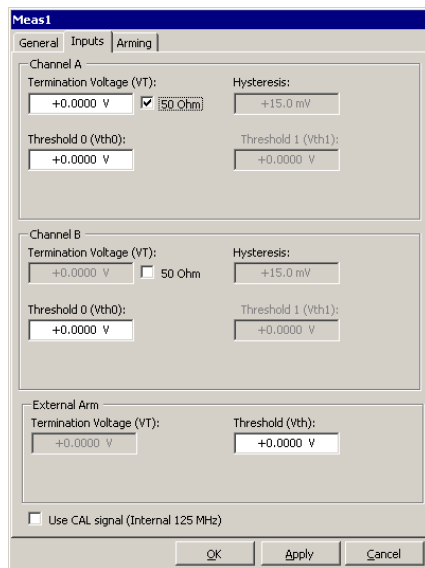

Figure 2. Instrument Options

The BI220 measurement options are shown in Figure 3.



The General panel is set to a 1 channel, 1 edge TIA function for Ch A with 1 1000-point block.



The Inputs panel sets Channel A to 50 Ω , 0 volt threshold.

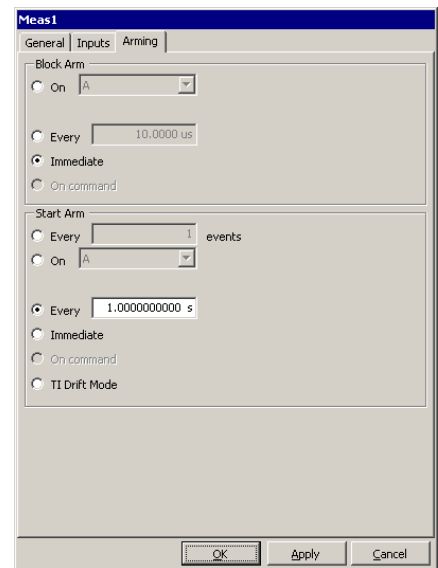

The Arming panel is set to immediate block arm and a start arm every 1 second.

Figure 3. Measurement Options

The BI220 software supports multiple displays, including data plots, histograms, statistics, tables and data streaming.

The BI220 graph options are shown in Figure 4.

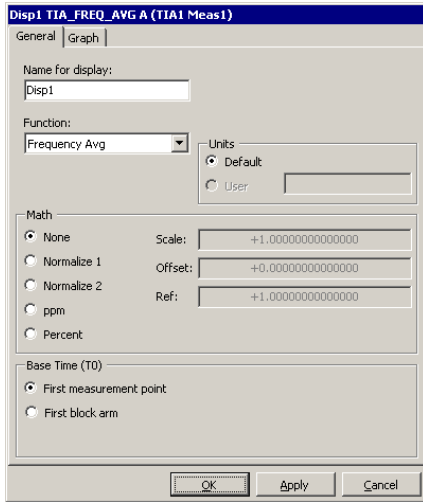

The General panel is set to plot the frequency average without math.

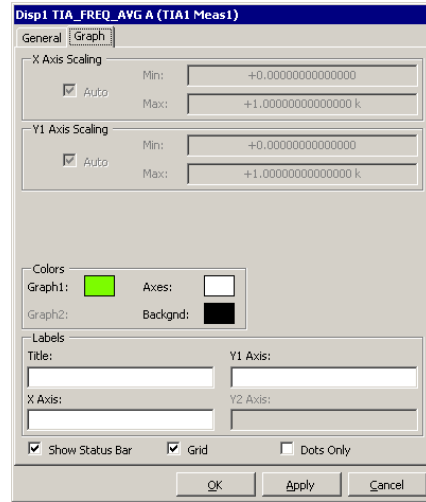

The graph panel is set to its defaults.

Figure 4. Graph Options

The BI220 digital options are shown in Figure 5.

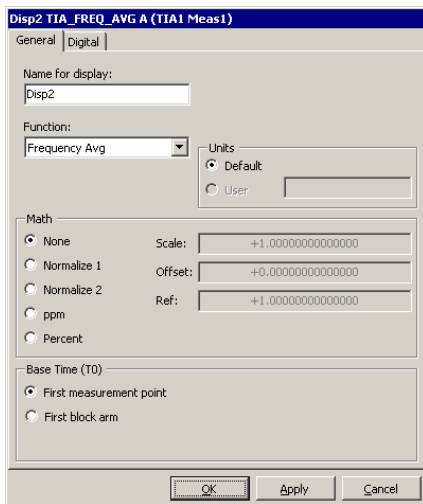

The General panel is set to show statistics related to the frequency average.

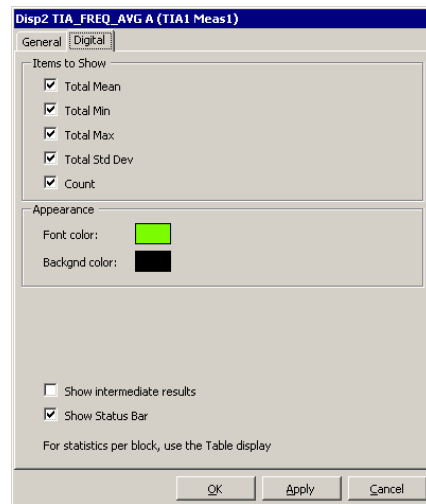

The Digital panel is set to show all items. Check the Show intermediate results box to show these items as data are acquired.

Figure 5. Digital Options

The BI220 data streaming options shown in Figure 6.

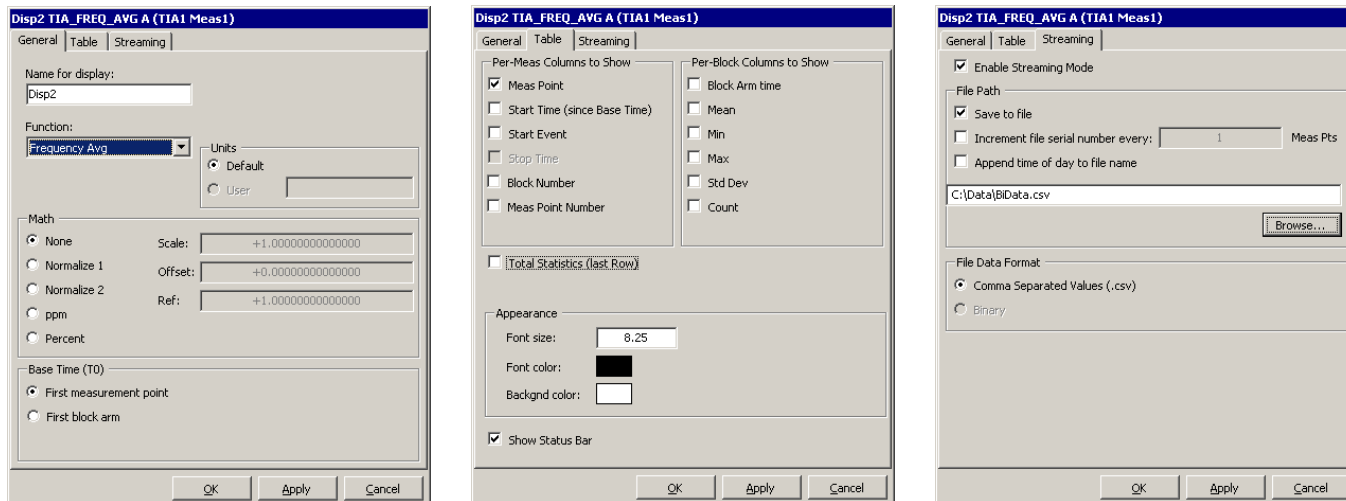

The General panel is set to frequency average with no math.

The Table panel is set to include only the measurement point.

The Streaming panel is set for streaming data to a file.

Figure 6. Data Options

If desired, one of the ppm or normalize math options can be used to convert the results to fractional frequency as required for a Stable32 analysis, although that can be done in Stable32 itself, either as the data are read (see Inputs) or with the Scale function.

- **Frequency Counter**

Frequency measurements can be made with a frequency counter by simply applying the signal under test to the counter input. The instrument also requires a frequency reference, either internal or external. Accurate measurements generally require that and external reference be used. Modern interpolating reciprocal frequency counters make period measurements using analog interpolation to increase their resolution. The BI220 uses an 80 MHz internal clock to make digital period measurements with 12.5 ns resolution that are enhanced to 8 ps single-shot resolution.

The BI220 was setup to make 1000 $\tau=1$ second measurements on the small ovenized 10 MHz crystal oscillator versus the rubidium oscillator reference. The data are streamed in exponential format to a file .csv which is compatible with both Microsoft Excel and Stable32. The data are written as a single column of measurement point values with a 1-line header that includes the start date and time as shown in the example below. The header line begins with a non-numeric character and is therefore ignored by Stable32. It can be used to create MJD timetags if needed. The BI220 is also capable of making measurements much faster at shorter sampling times, but at reduced resolution.

```
MeasPoint,2012 02 06 10:51:33
1.00000321562004e+007
1.00000321676586e+007
1.00000321639264e+007
1.00000321629488e+007
```

The 1000-point, $\tau=1$ second frequency counter run was set up with data streaming, statistics and graph panels, and produced the results shown in Figure 7.

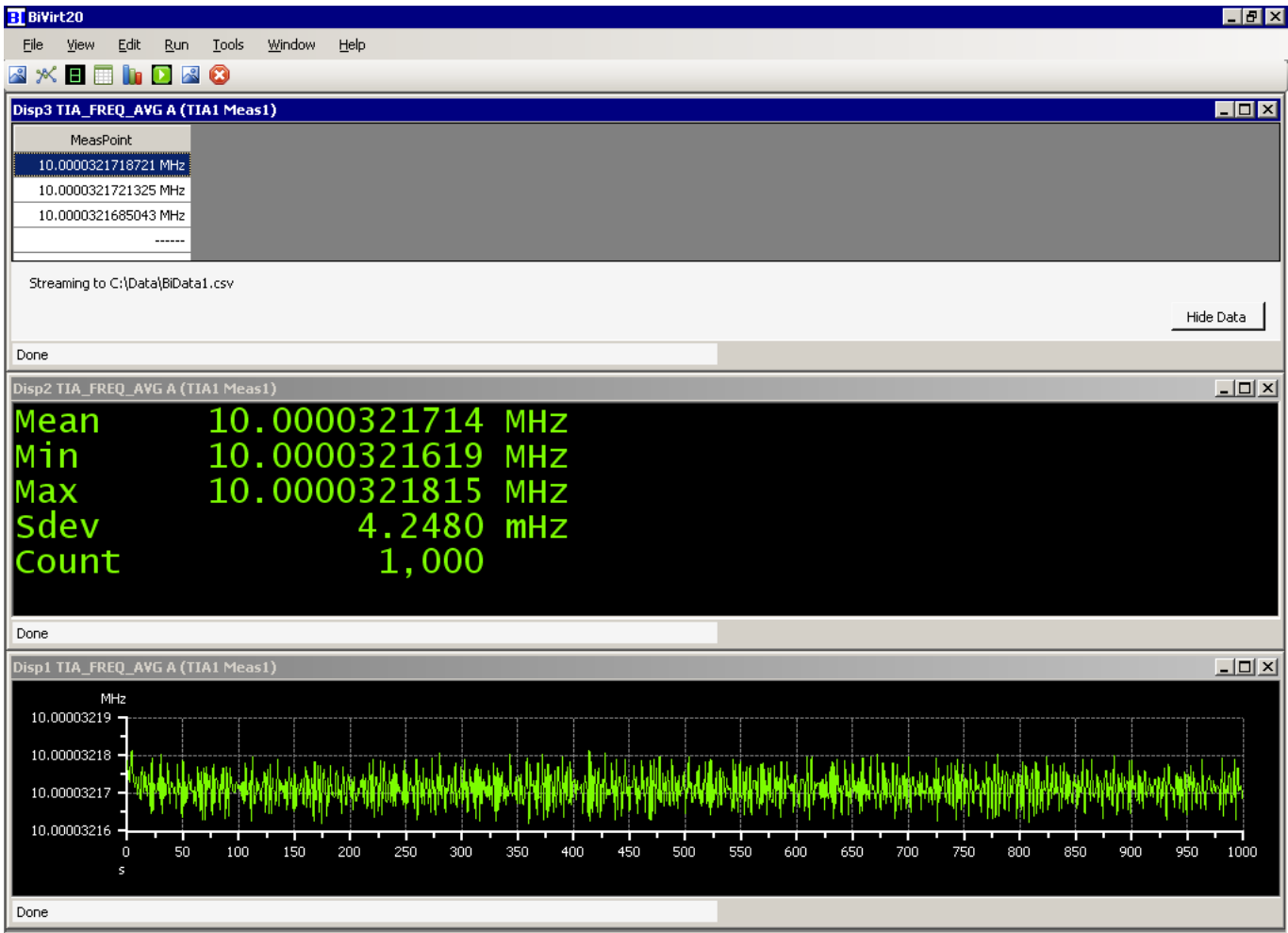

Figure 7. Results of Frequency Counter Measurement Run

The top panel shows the final portion of the streaming data. That display updates as the data is acquired and therefore serves as a progress indicator overall. The middle panel shows the statistics for the overall run, including a $\tau=1$ second standard deviation of about 4.2×10^{-10} . The bottom panel contains a plot of the data, which appears to be “violet” (white PM) noise [4] with no outliers, cycling or drift. Unfortunately, the plot does not update dynamically as the data is collected, but only at the end of the run.

The Stable32 analysis starts by simply reading the BiData.csv file and examining its data with the Statistics function as shown in Figure 8. Notice that the standard deviation value is the same. The raw frequency data must be converted to fractional frequency before continuing with the analysis. That is done with the Scale function by first subtracting $1e7$ and then dividing by $1e7$. The data are then normalized by removing their average value of about 3.22 ppm.

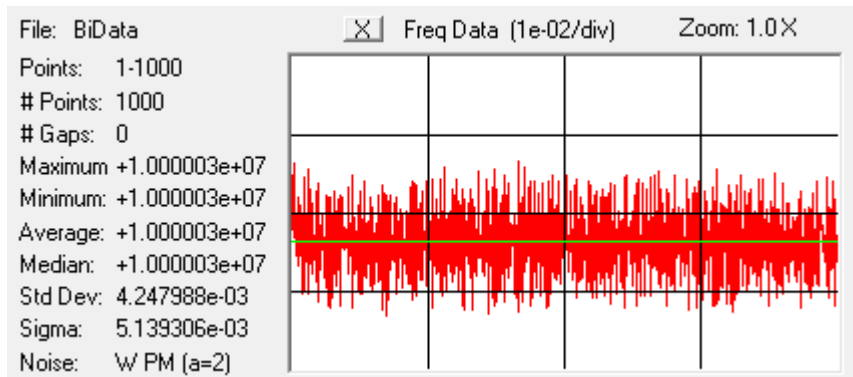

Figure 8. Raw Frequency Counter Data Statistics

The average frequency value agrees with that of a conventional Racal/Dana 1992 high-resolution universal counter. The resulting frequency and frequency stability plots are shown in Figures 9 and 10 respectively. The -1 slope of the ADEV curve identifies the short-term noise as white PM ($\alpha=2$) at a level of about 5.5×10^{-10} at 1 second. That is not the noise type expected for a crystal oscillator in that region (flicker FM) and is at least an order-of-magnitude larger than expected. The noise is therefore almost certainly that of the measuring system (BI220 counter) rather than the crystal oscillator under test (or the rubidium reference). We conclude that the BI220 is inadequate to directly measure the performance of a moderately high stability ovenized crystal oscillator, and that this test characterizes the noise floor of the instrument. Its useful resolution is therefore about $9 \frac{1}{2}$ rather than 11 digits at 1 second. The noise floor was not improved significantly by adding a 15 MHz low pass filter at the A Channel input.

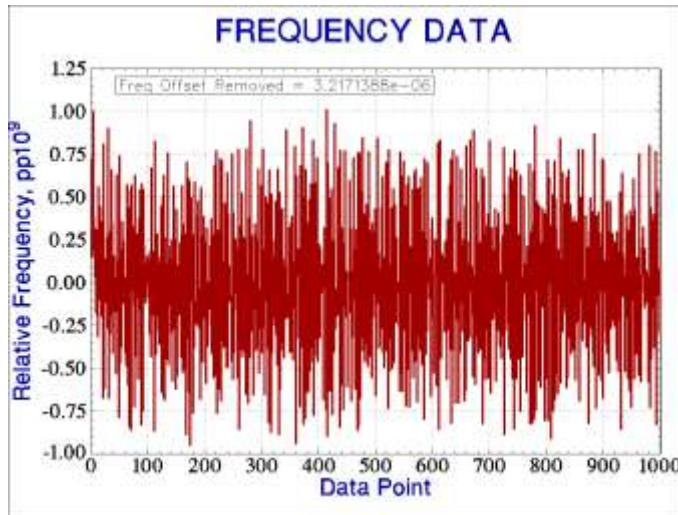

Figure 9. Fractional Frequency Data Plot

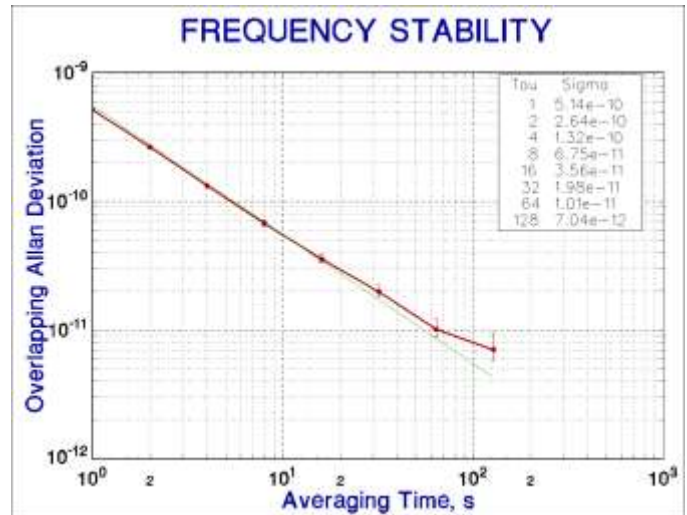

Figure 10. Frequency Stability Plot

• **Heterodyne Frequency Measuring System**

The heterodyne method mixes (subtracts) the two sources being compared, and measures the frequency or period of the resulting audio-frequency beat note as shown in the block diagram of Figure 11. The measurement resolution is increased by the heterodyne factor (the ratio of the carrier to the beat frequency).

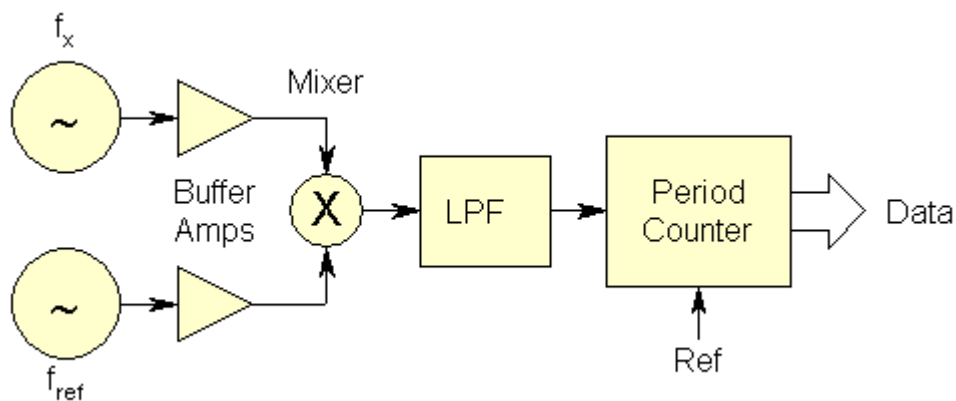

Figure 11. Block Diagram of Heterodyne Frequency Measuring System

This test of a heterodyne frequency measuring system takes advantage of the ≈ 32 Hz offset of the crystal oscillator under test (obtained by detuning it with its control voltage). In general, an offset reference source may be required (such as a DDS synthesizer). The expectation is that the BI220 noise and resolution will be improved by the heterodyne factor ($\approx 3 \times 10^5$), or at least enough so that the stability of the crystal oscillator can be measured. In fact, it is expected that the OCVCXO and Rb reference will both have 1-second stabilities on the order of 1×10^{-11} .

The additional hardware consists of a heterodyne module comprising a passive double-balanced diode mixer, a low pass filter and a DC-coupled beat note amplifier. The RF input to the mixer is from the crystal oscillator under test and the LO input is from the same rubidium oscillator as used for the BI220 reference. The output from the heterodyne module is a ≈ 32 Hz quasi-squarewave with an amplitude of about 5 volts p-p which is applied to the BI220 A channel input which is set to high impedance and a threshold approximately equal to the average level of the beat signal. All other BI220 settings are the same as for the direct frequency measurement. Because of the high BI220 input sensitivity and wide bandwidth, it was found advantageous to add an audio low pass filter at its input (e.g., 10 k Ω and 0.47 μ F). An input attenuator and low pass filter would be a useful addition to the instrument.

The results of the heterodyne frequency counter measurement are shown in Figure 12.

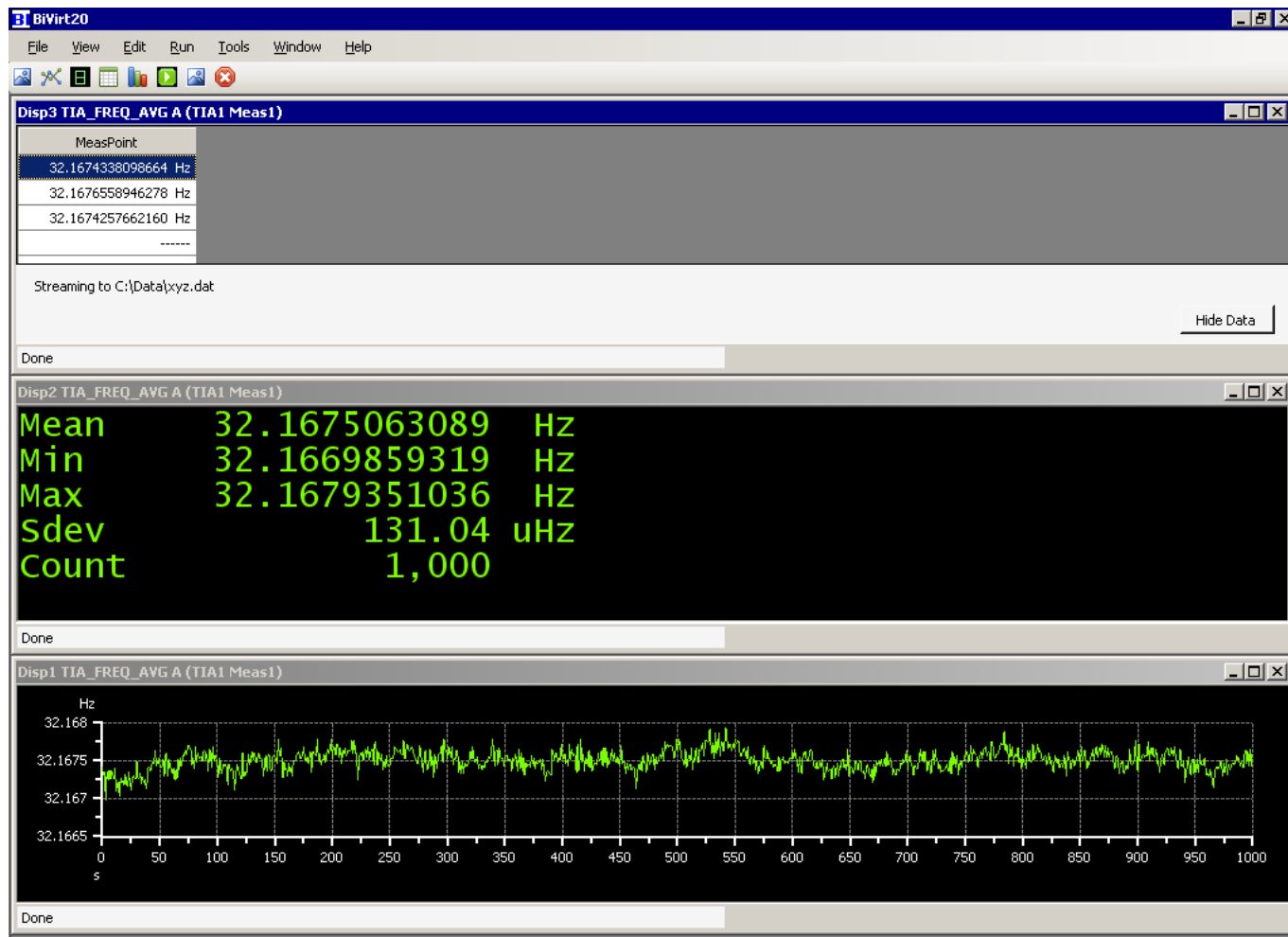

Figure 12. Results of Heterodyne Frequency Counter Measurement Run

The standard deviation of this heterodyne frequency measurement run was much better, about 130 μHz or 1.3×10^{-11} , and the noise looks like it is between white and flicker FM. Those results are indeed what are expected for the OCVCXO and Rb reference. Because the nominal 10 MHz is already subtracted by the mixer, fractional frequency values are obtained by simply dividing by $1e7$.

The resulting frequency and frequency stability plots are shown in Figures 13 and 14 respectively. The $-\frac{1}{2}$ and 0 slopes of the ADEV curve identifies the short-term noise as white and flicker FM noise at a level of about 0.9×10^{-11} at 1 second. The Rb reference has white FM noise that would decrease as $1/\sqrt{\tau}$ at averaging times longer than 1 second but the results do not, and represent the instability of the crystal oscillator.

We conclude that the BI220 TIA is able to measure the stability of a moderately high source when augmented with a heterodyne module.

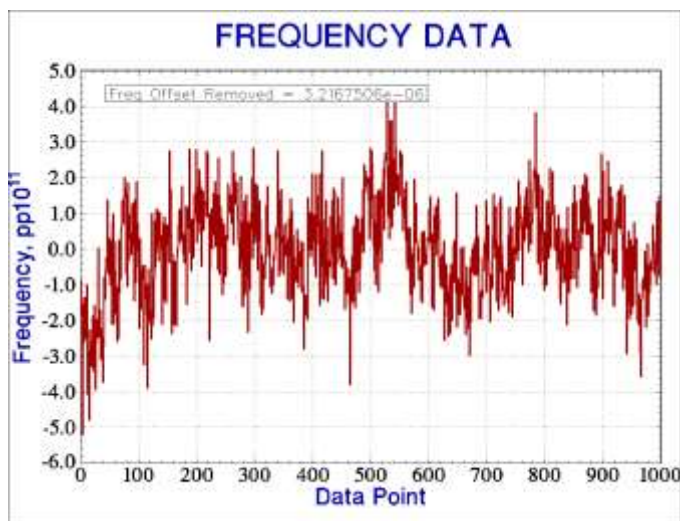

Figure 13. Fractional Frequency Data Plot

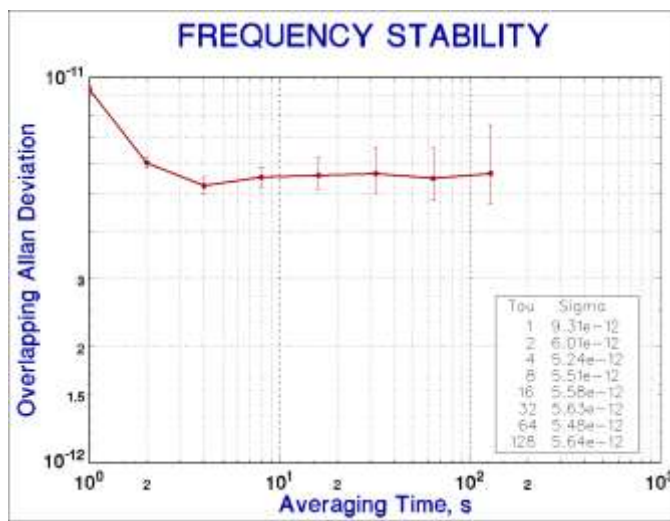

Figure 14. Frequency Stability Plot

• **1 PPS Clock Measuring System**

The 1 pps clock measuring system divides the two sources being compared down to 1 pps (or another low rate) and measures their time difference with the BI220 configured as a high resolution time interval counter as shown in the block diagram of Figure 15.

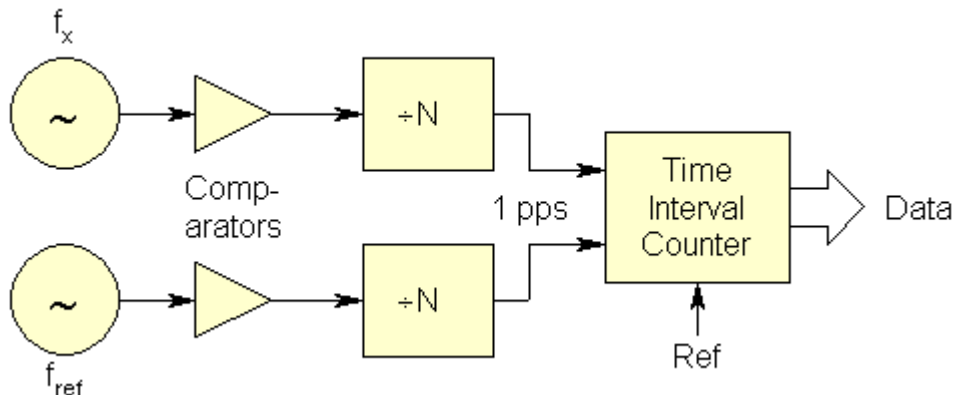

Figure 15. Block Diagram of 1 PPS Time Interval Counter Clock Measuring System

This measurement method is made practical by the BI220s high-resolution interpolating time interval mode that offers 12-digits/second resolution (but a larger noise level). That resolution is not affected by the division ratio, which sets the minimum measurement time, and, along with the frequency offset, determines how long data can be taken before experiencing a phase spillover.. For example, a source having a frequency offset of 1×10^{-6} can be measured for about 5.8 days before experiencing a 1 pps phase spillover after being initially centered at a phase difference of 0.5 second. Stable32 has specific means for removing phase spillovers if necessary. This measurement method is appropriate for frequency sources having medium stability (such as a non-ovenized crystal oscillator) and particularly for comparing a local clock against a GPS timing reference. The 10 MHz to 1 pps divider hardware can be as simple as a single 8-pin PIC microcontroller chip [3]. No divider is needed if a 1 pps signal is available from the source (e.g., a GPS timing receiver).

The results of the 1pps time interval counter measurement are shown in Figure 16.

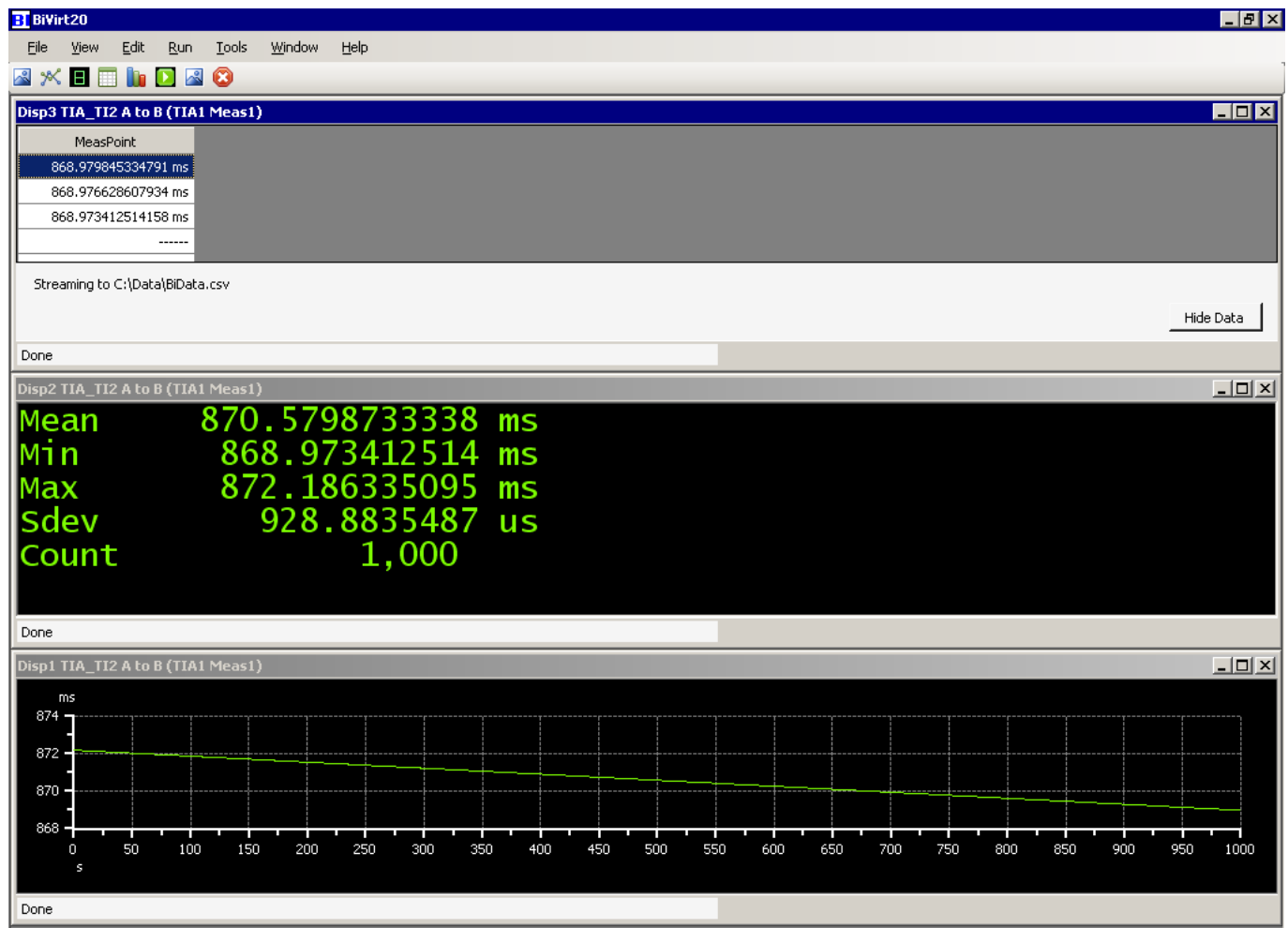

Figure 16. Results of 1PPS Time Interval Counter Measurement Run

The phase record is nearly a straight line whose slope represents the frequency offset of the crystal oscillator. The noise of the measuring system, crystal oscillator and reference cause small variations around this line. Stable32 can “peel away” the information contained in the raw phase record, but there is no reason to believe that the basic BI220 will be low enough to characterize the crystal oscillator,

especially since the wideband instrument input is not optimized for detecting the zero-crossings of the 1 pps signals.

The various steps in performing a Stable32 analysis on the 1 pps time interval data are shown in Figures 17 through 22. Figure 17 shows the raw phase record whose slope of about -3.215×10^{-6} represents the frequency offset of the crystal oscillator with respect to the Rb reference (negative in this case because of the reversed input connections). Figure 18 shows the phase residuals after removing this slope and the resulting phase offset. The reason for the slow phase variation isn't known but is probably room temperature thermal change affecting the crystal oscillator. The corresponding relative frequency plot is shown in Figure 19 and its Allan deviation stability in Figure 20, whose slope indicates that it is white PM noise from the measuring system (BI220) at a level of about 4.6×10^{-10} at 1 second, close to that found by direct frequency counter measurements and an order-and-a-half in magnitude higher than the OCVCXO unit under test. Figures 21 and 22 continue the analysis for TDEV and MTIE. But it is clear that the measuring system noise dominates the results and that they therefore say little about the crystal oscillator under test.

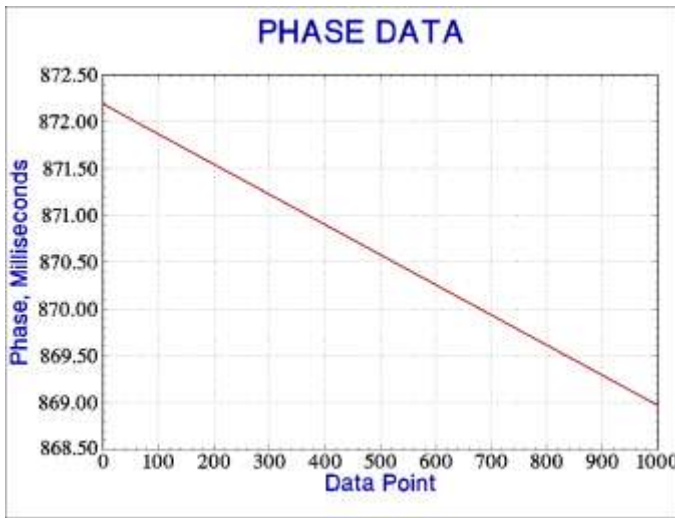

Figure 17. Phase Data Plot

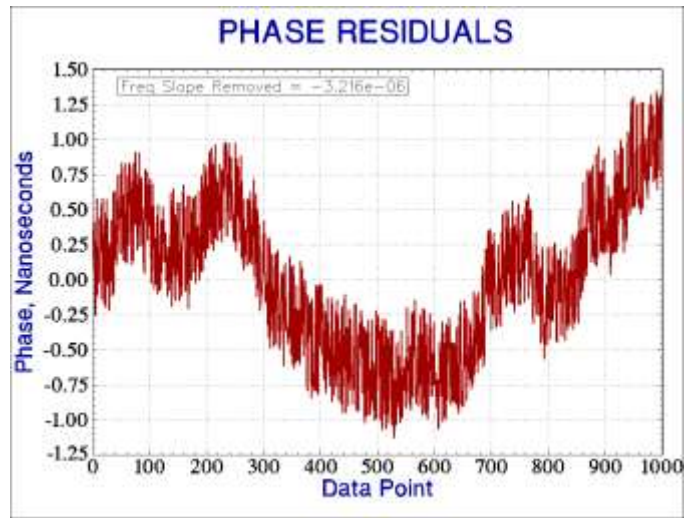

Figure 18. Phase Residuals w/o Frequency Offset

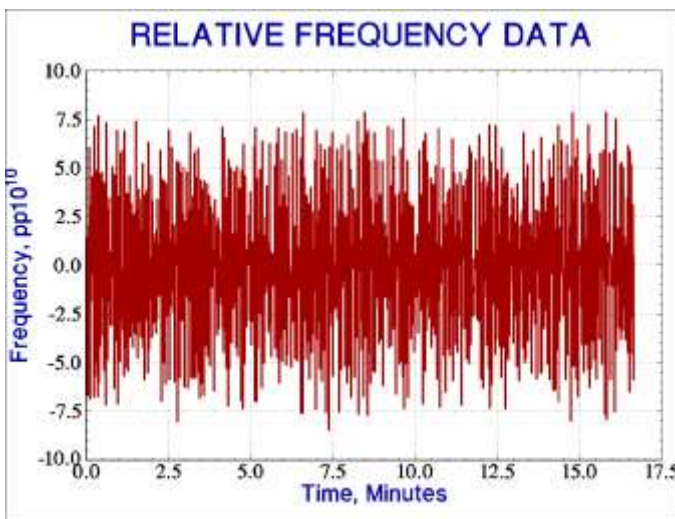

Figure 19. Relative Frequency Data Plot

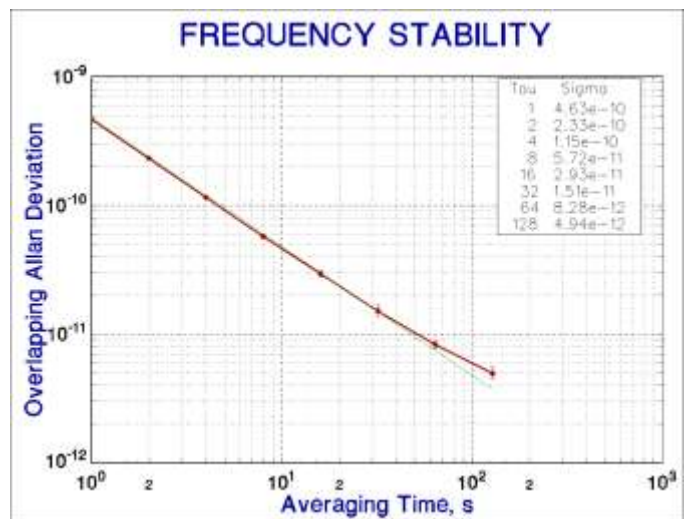

Figure 20. Frequency Stability Plot

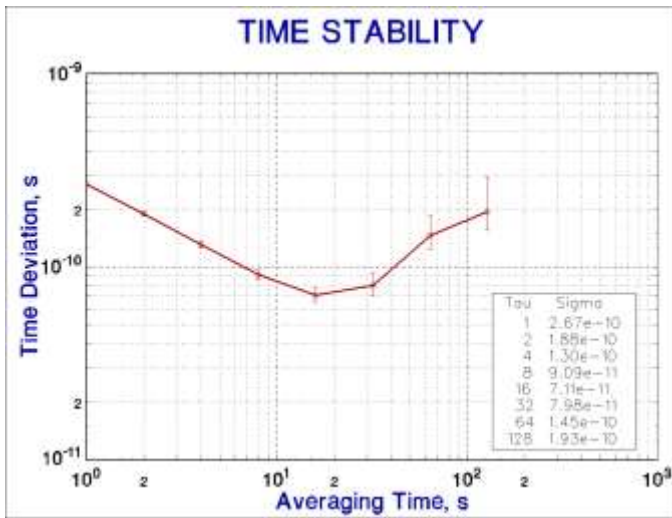

Figure 21. Time Deviation Plot

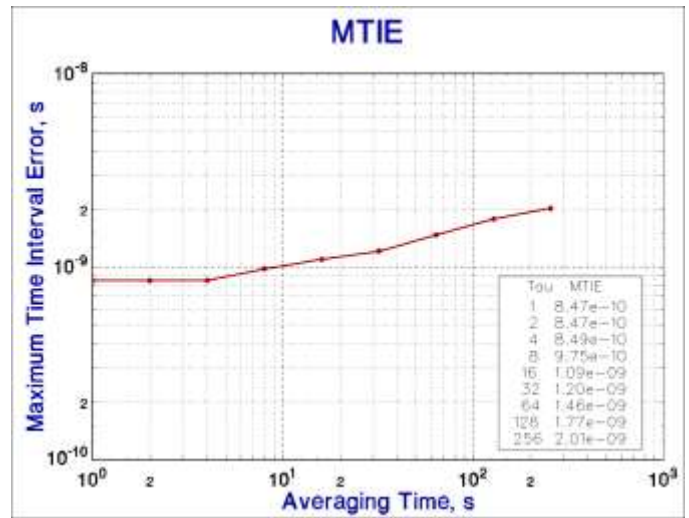

Figure 22. MTIE Plot

• **Dual Mixer Time Difference (DMTD) Clock Measuring System**

A DMTD clock measuring system combines the best features of the heterodyne and time interval systems by using a time interval counter to measure the relative phase of the beat signals from a pair of mixers driven from a common offset reference, as shown in the block diagram of Figure 23.

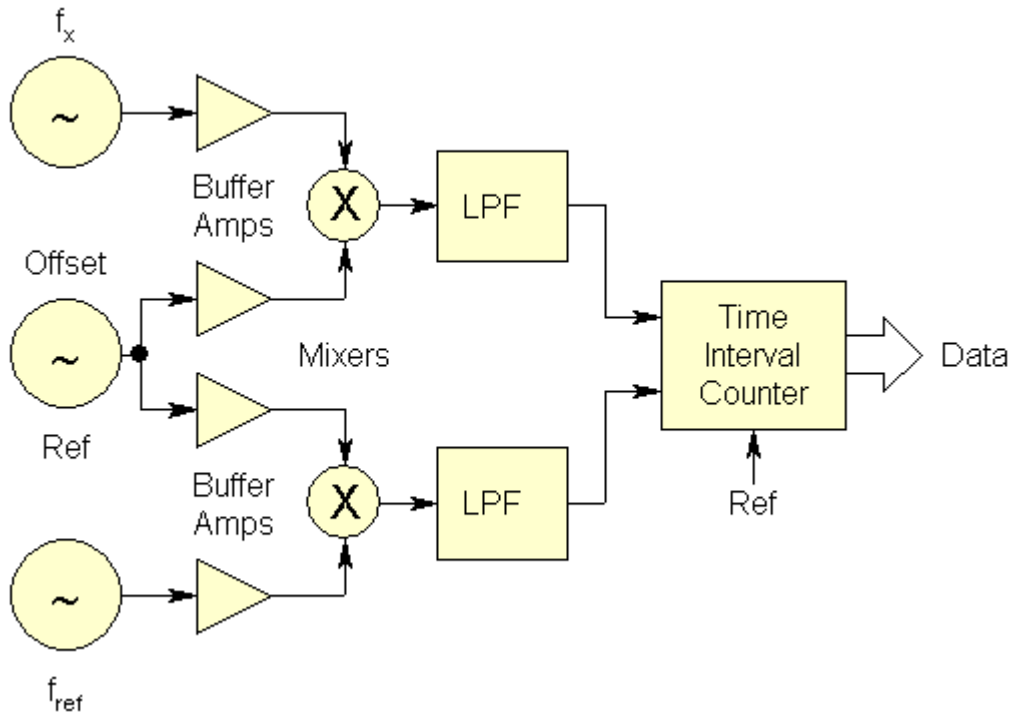

Figure 23. Block Diagram of Dual Mixer Time Interval Clock Measuring System

The DMTD clock measuring system used here is based on a previously-described small DMTD system [5] with the internal time interval counter replaced with the BI220 instrument. This system is configured for measuring frequency sources at or very near 10 MHz, so the OCVCXO under test was adjusted to near zero-beat. Phase spillovers occur at 100 ns (the 10 MHz period), which will happen every 1000 seconds for a frequency offset of 1×10^{-10} . While these can be removed during a Stable32 analysis, they should be

kept to a minimum, therefore requiring that the source under test have only a small frequency offset. The offset LO is a 10 MHz + 10 Hz free-running low noise MTI Model 250 OCVCXO which provides phase samples at $\tau=0.1$ second.

A preliminary run using the internal PICTIC DMTD system time interval counter showed a 1-second ADEV stability of the combination of the OCVCXO under test and the rubidium oscillator reference of about 7.5×10^{-12} .

The BI220 is set up for two-channel, two-edge time interval operation with high impedance +2.5 volt threshold inputs using immediate block and sample arming. The run is configured to capture 10,000 0.1 second samples to a streaming data file. The 100 ms full-scale TIC reading corresponds to a 100 ns carrier cycle period because of the $10 \text{ Hz}/10 \text{ MHz} = 1e6$ heterodyne factor.

The results of the DMTD measurement are shown in Figure 24.

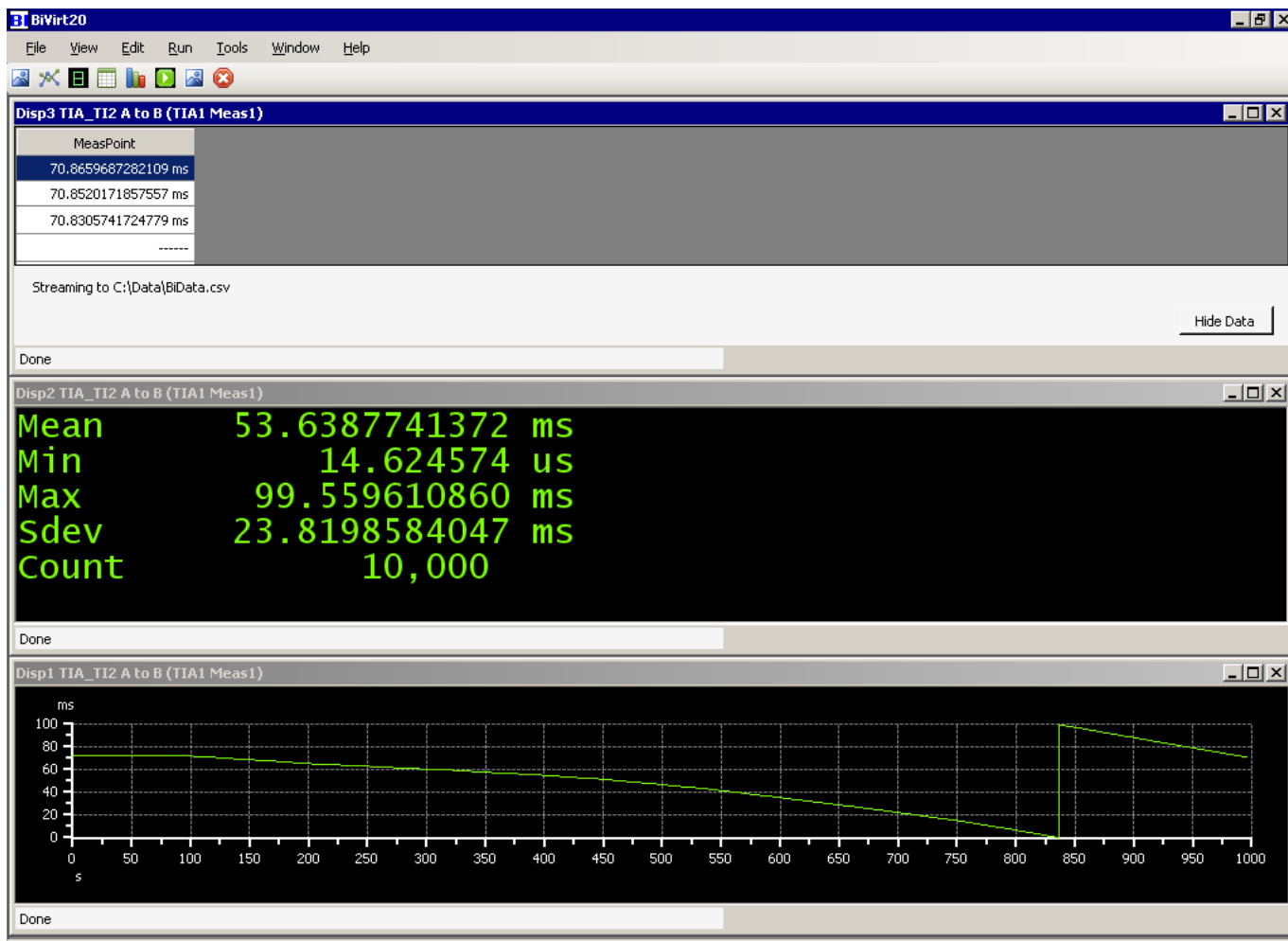

Figure 24. Results of DMTD Measurement Run

These results are analyzed in Stable32 as shown in Figures 25 through 30. First, the carrier cycle spillover in Figure 26 is removed from the phase data in Figure 27, which is then converted to frequency data in Figure 28, which shows that it begins close to zero-beat and then decreases to about -1.75×10^{-10} over the ≈ 15 -minute run. The resulting frequency stability, about 7.3×10^{-10} at 1-second, agrees with the

internal PICTIC value. That combined OCVCXO and Rb reference instability becomes dominated by the OCVCXO at longer averaging times due to flicker FM noise and the frequency drift. The drift-removed instability is flat flicker FM noise at a level slightly below 1×10^{-11} , somewhat higher than that found by the heterodyne counter measurement. The corresponding TDEV and MTIE plots (without drift removal) are shown in figures 29 and 30 respectively. The wide BI200 input bandwidth is not optimum for noise considerations when measuring the time interval between the DMTD zero crossing detector outputs.

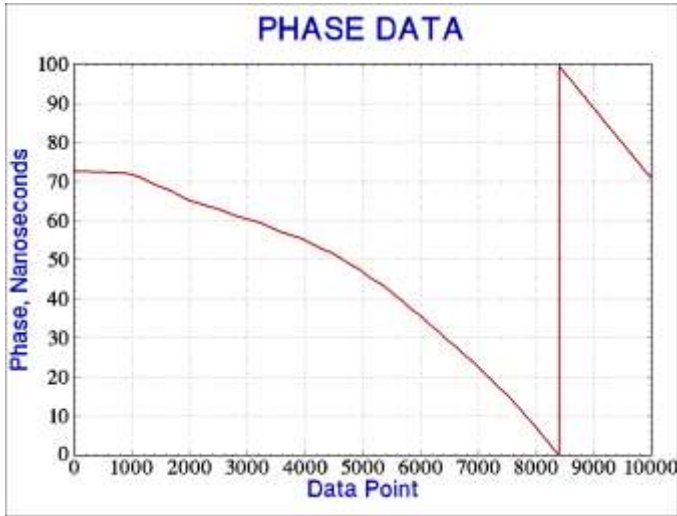

Figure 25. Raw Phase Data

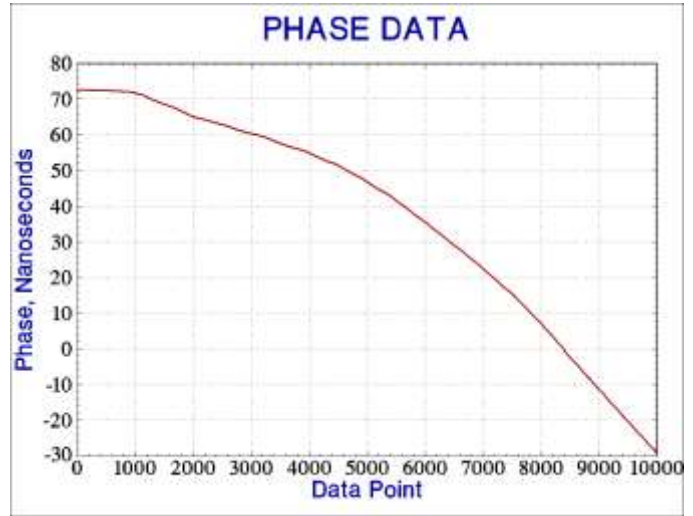

Figure 26. Phase Data After 100 ns Step Removal

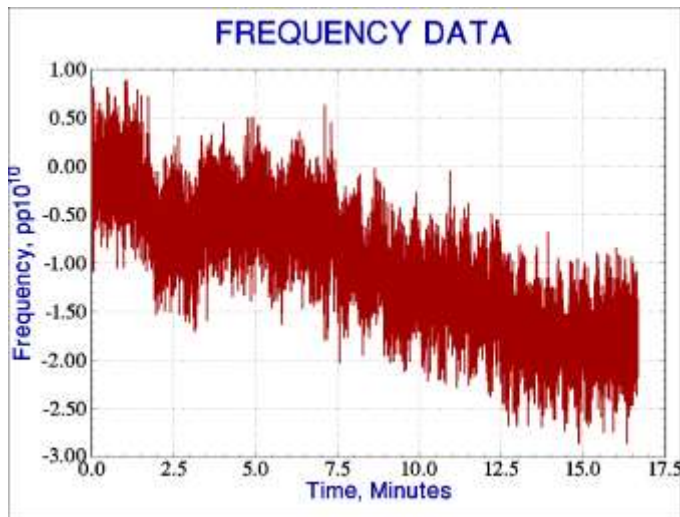

Figure 27. Frequency Data Plot

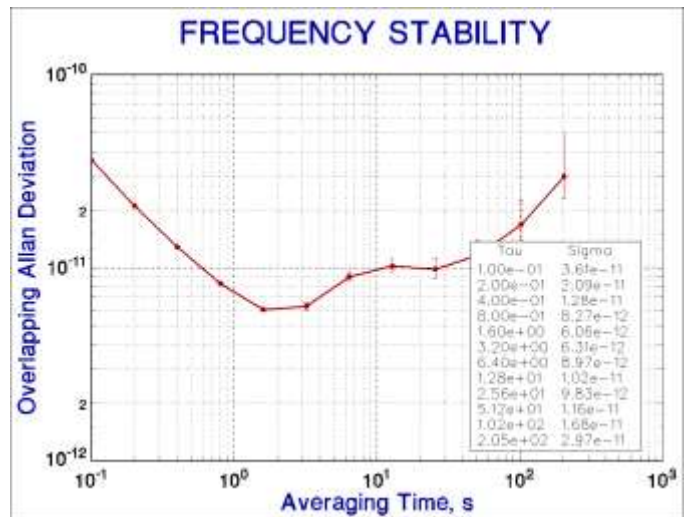

Figure 28. Frequency Stability Plot

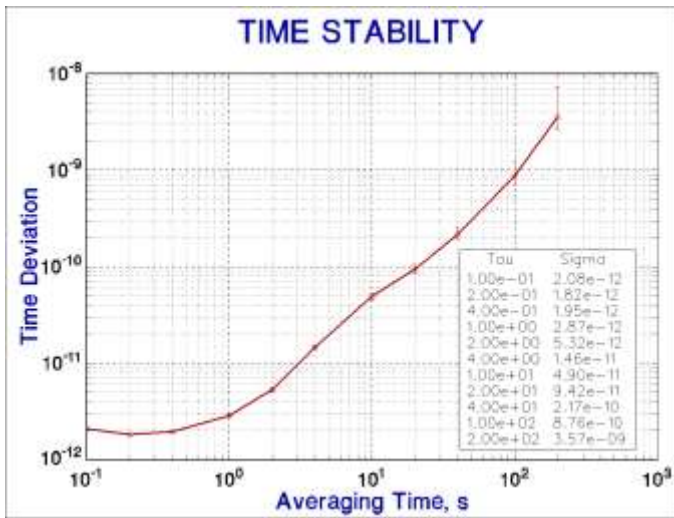

Figure 29. Time Deviation Plot

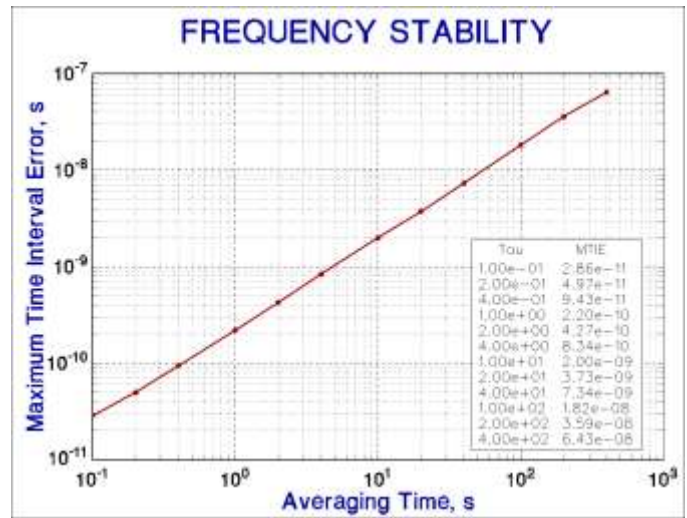

Figure 30. MTIE Plot

• **Dual Mixer Time Difference (DMTD) Clock Measuring System Using Time Tags**

Approximately the same results can be obtained with the BI220 TIA in the 2C2E mode by recording the start and stop timetags and using their differences (obtained by subtracting the start time from the stop time in an Excel spreadsheet). The values vary from zero to 0.1 second, corresponding to zero to 100 ns because of the 10^6 heterodyne factor. A sample of these data is shown in Figure 31 along with a plot of the entire run. The spillover rate has increased because the OCVCXO frequency difference is larger. There is no advantage of the timetag method compared with recording time interval data.

StartTime	StopTime	2012 02 08 17:00:09	Delta Time
0	0.034395		0.0343951280639000
0.099592	0.133868		0.0342762856654700
0.199185	0.233341		0.0341561061209900
0.298778	0.332815		0.0340365149837100
0.398376	0.432288		0.0339121423854700
0.497964	0.531761		0.0337973596922100
0.597553	0.631235		0.0336816573624000
0.697149	0.730709		0.0335599655410400
0.796734	0.830183		0.0334490995262200

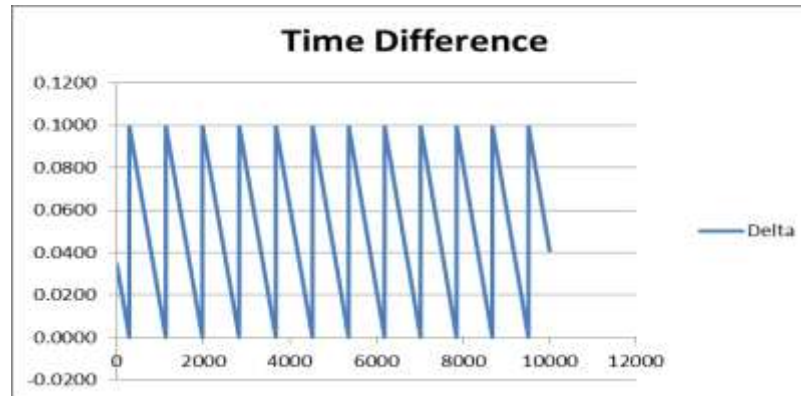

Figure 31. Start, Stop and Time Difference Timetag Data

• **Noise Floor**

The noise floor of BI220 TIA depends of the properties of the input signal (waveform, amplitude, noise, rise time and frequency) and generally exceeds the instrument's resolution because it has a very wide input bandwidth and is therefore susceptible to wideband noise. It is particularly important that low frequency signals (e.g., 1 pps) be conditioned with fast rise time, in which case the manufacturer expects a jitter of about 8 ps p-p. 10 MHz sinewave signals with an amplitude of 1 volt p-p can be expected to show a standard deviation of 30-40 ps, and the author has measured a 1-second TDEV of 10 ps for coherent +7 dBm signals at 100 MHz.

- **Acknowledgment**

The BI220 Time Interval Analyzer used for these measurements was provided to Hamilton Technical Services by Mr. Shalom Kattan of Brilliant Instruments, who also made constructive comments regarding this paper.

- **References**

1. Data Sheet, [BI220 Time Interval Analyzer/Counter](#), Brilliant Instruments, Inc., Campbell, CA 95008, November 2011.
2. Data Sheet, [Stable32 Software Package for Frequency Stability Analysis](#), Hamilton Technical Services, Beaufort, SC 29907, August 2008.
3. T. VanBaak, [picDIV Single Chip Frequency Divider](#), LeapSecond.com web site.
4. Wikipedia, [“Colors of Noise”](#).
5. W.J. Riley, [“A Small DMTD System”](#), Hamilton Technical Services, Beaufort, SC 29907, May 2010.

File: Clock Measurements Using the BI220 TIA.doc
W.J. Riley
Hamilton Technical Services
February 9, 2012
Rev. A March 16, 2012